

View axis D

30.08.2018

EMPLOYER	TITILE Tumaini CONSTRUCTION WORK Primary School	REPRESENTATION View axis D 9 Toilet Boys	DESIGNED BY F . Schramm Iringa P.O. BOX 164 1
----------	--	--	--

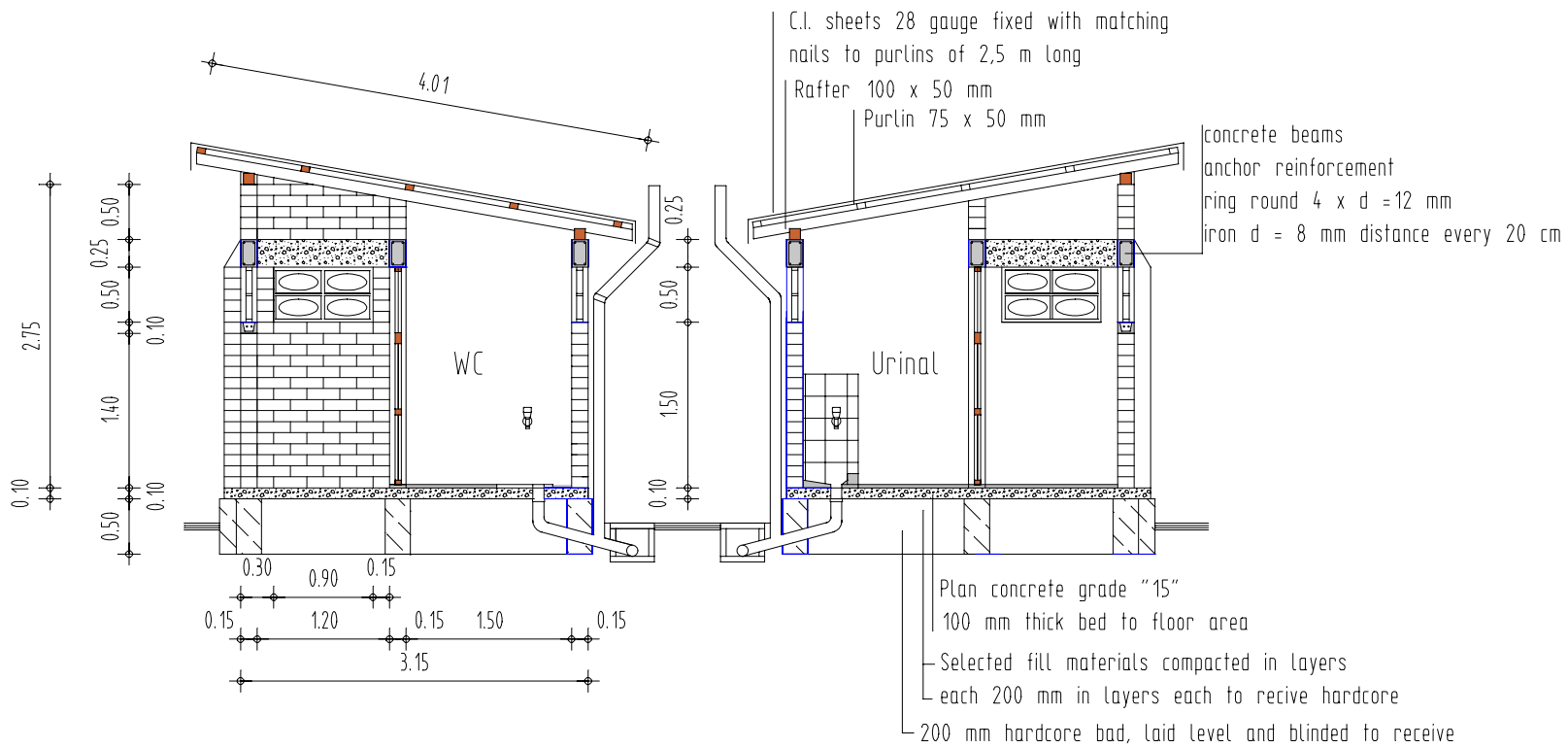

25.08.2019

EMPLOYER	TITLE	REPRESENTATION	DESIGNED BY
	CONSTRUCTION WORK	Section axis 4 Toilet Boys	F . Schramm Iringa
	Tumaini Primary School		P.O. Box 1641

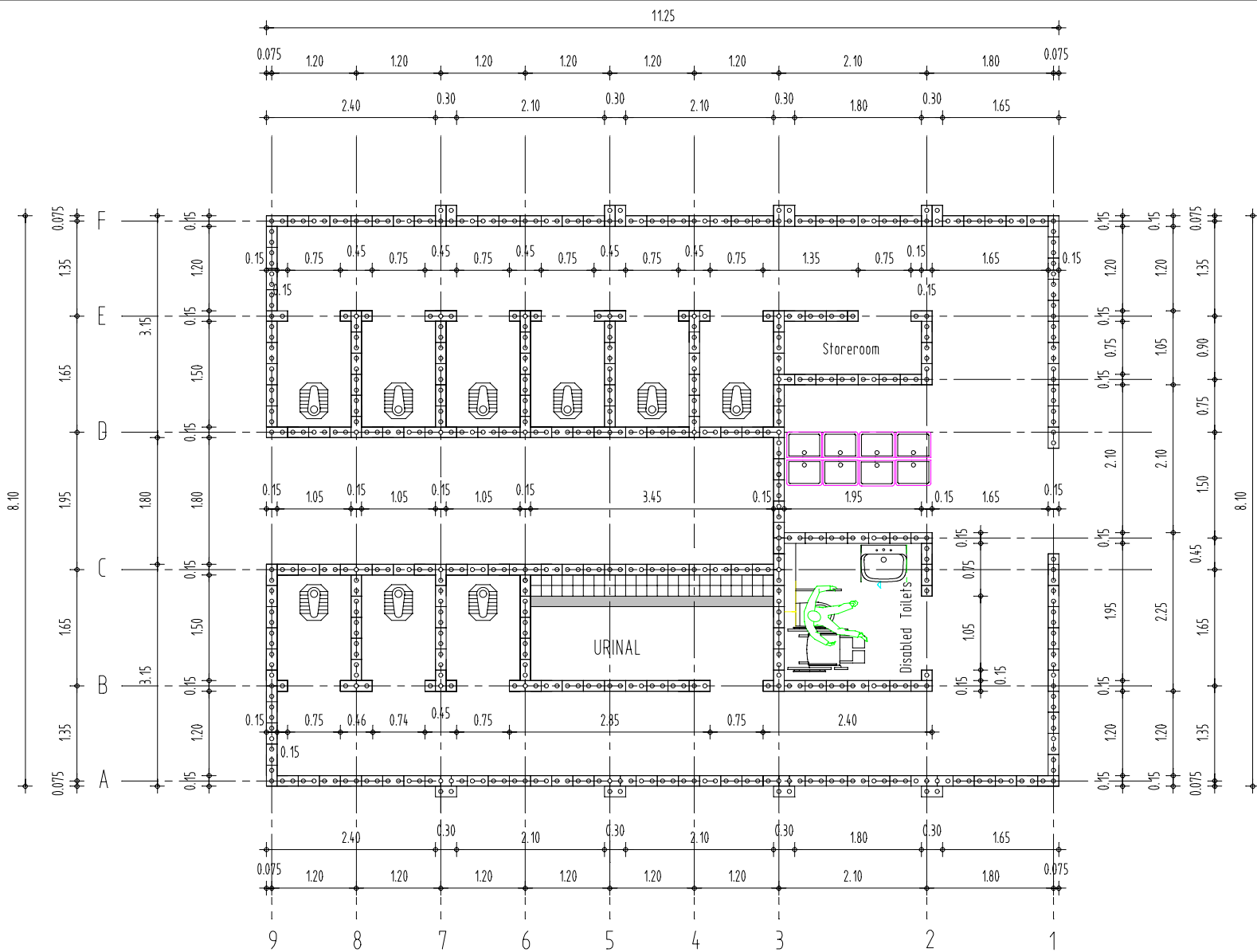

17.08.2018

EMPLOYER	TITLE Tumaini CONSTRUCTION WORK Primary School	REPRESENTATION Floor Plan 9 Toilet Boys	DESIGNED BY F . Schramm Iringa P.O. BOX 1641
----------	---	---	---

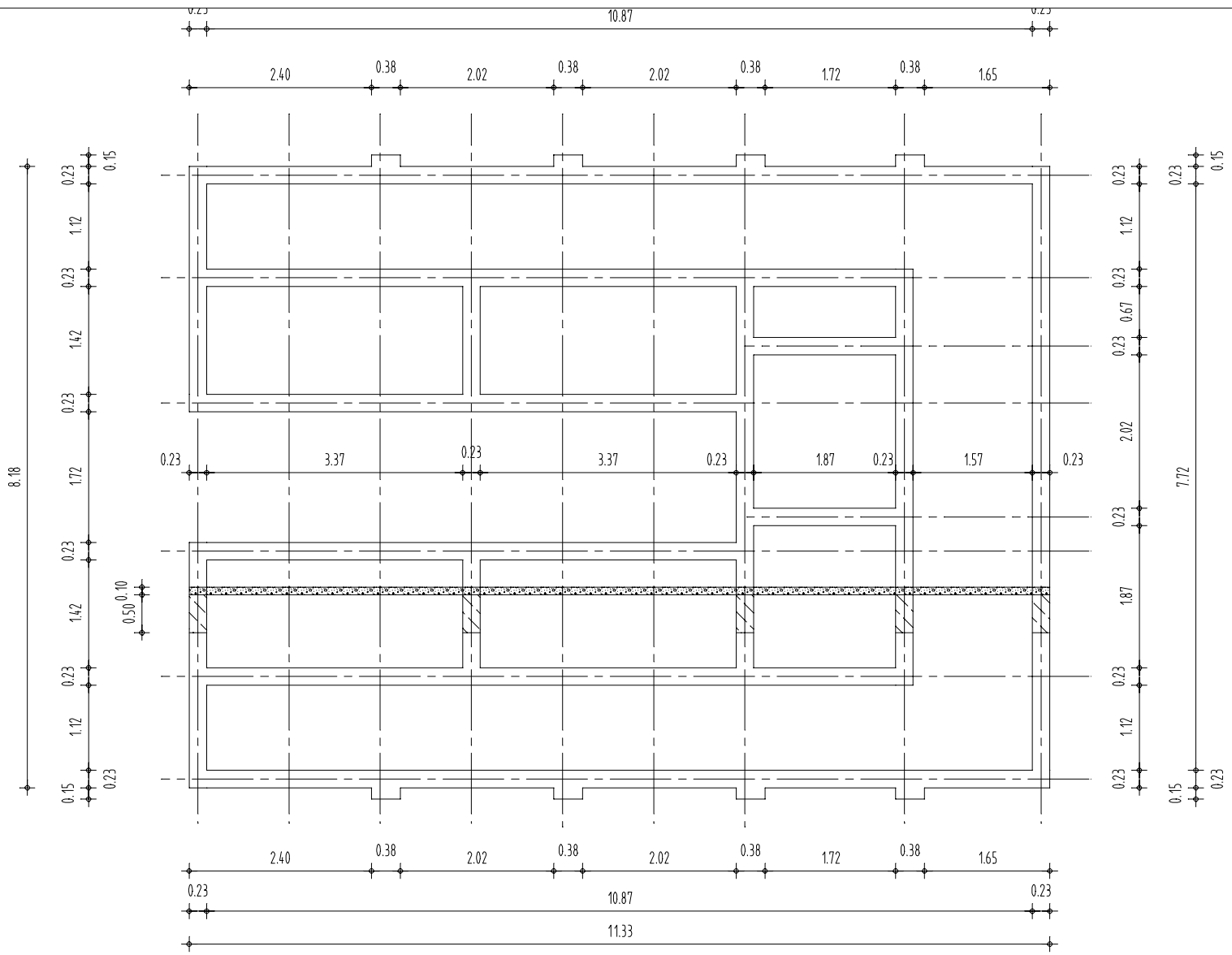

31.08.2018

EMPLOYER	TITLE Tumaini CONSTRUCTION WORK Primary School	REPRESENTATION Foundation 9 Toilet Boys	DESIGNED BY F . Schramm Iringa P.O. BOX 1641
----------	---	---	---

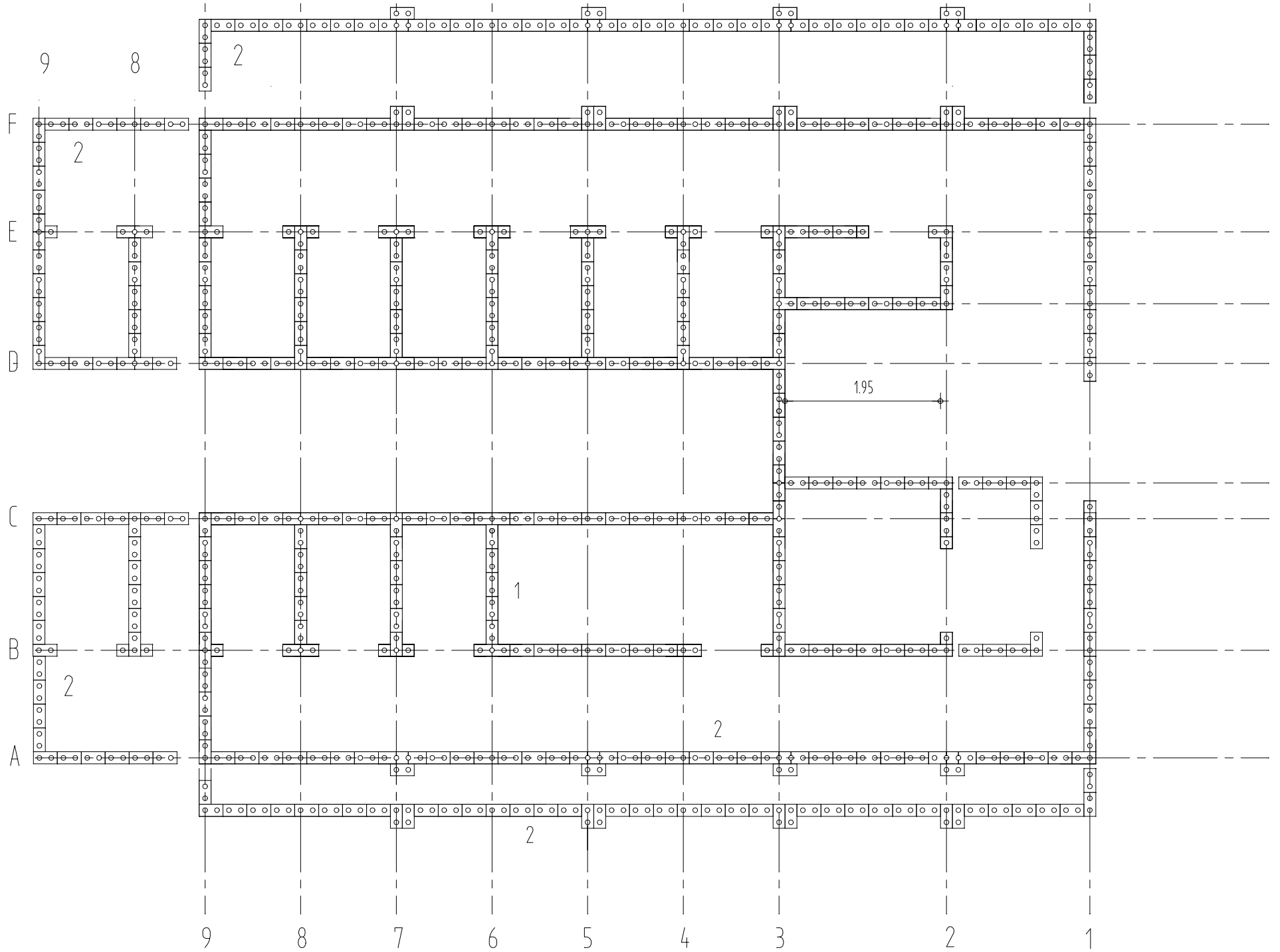

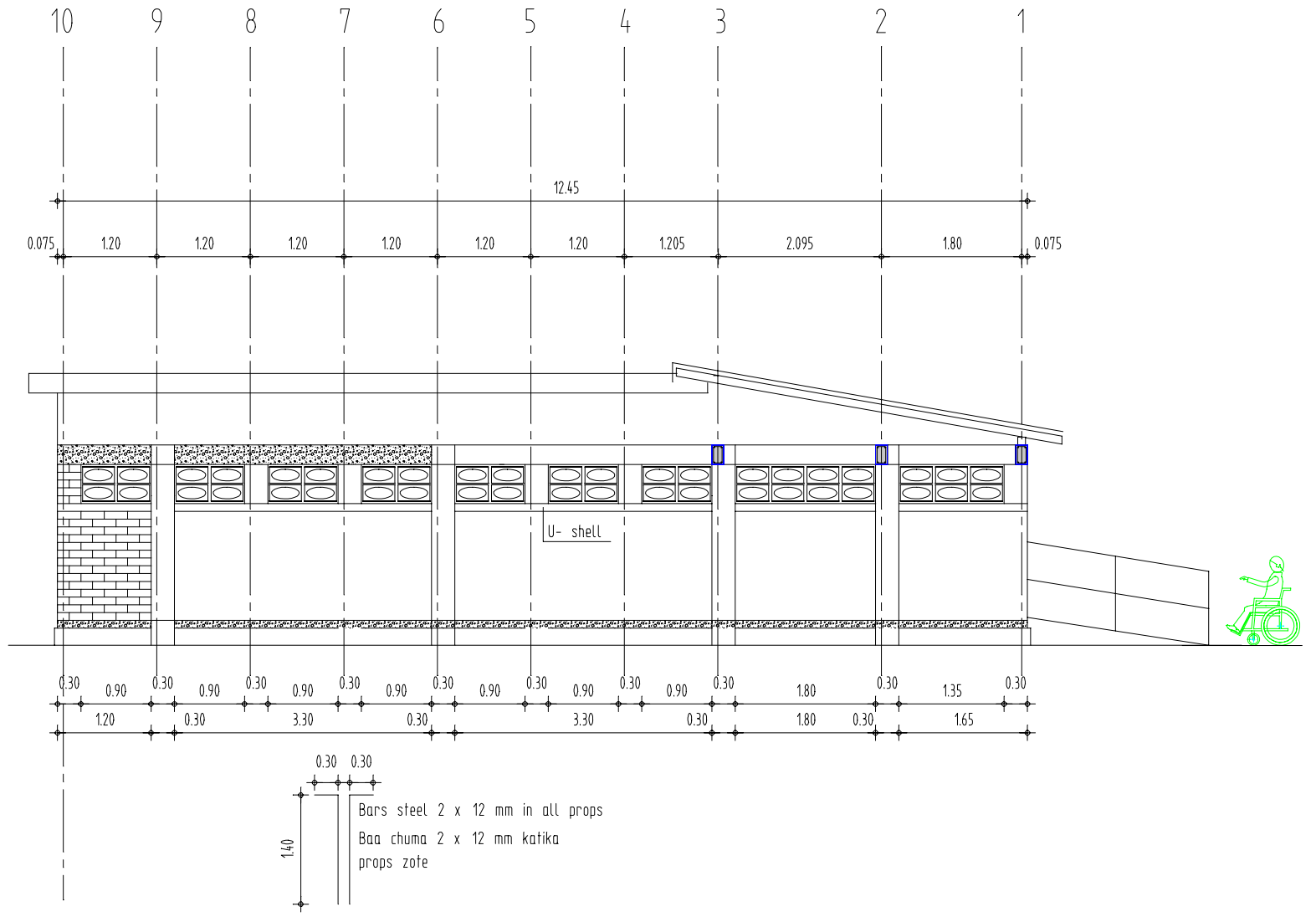

28.08.2019

EMPLOYER	TITLE CONSTRUCTION WORK Tumaini Primary School	REPRESENTATION 12 Toilet Girls View left side	DESIGNED BY F . Schramm Iringa P.O. BOX 164 1
----------	--	---	--

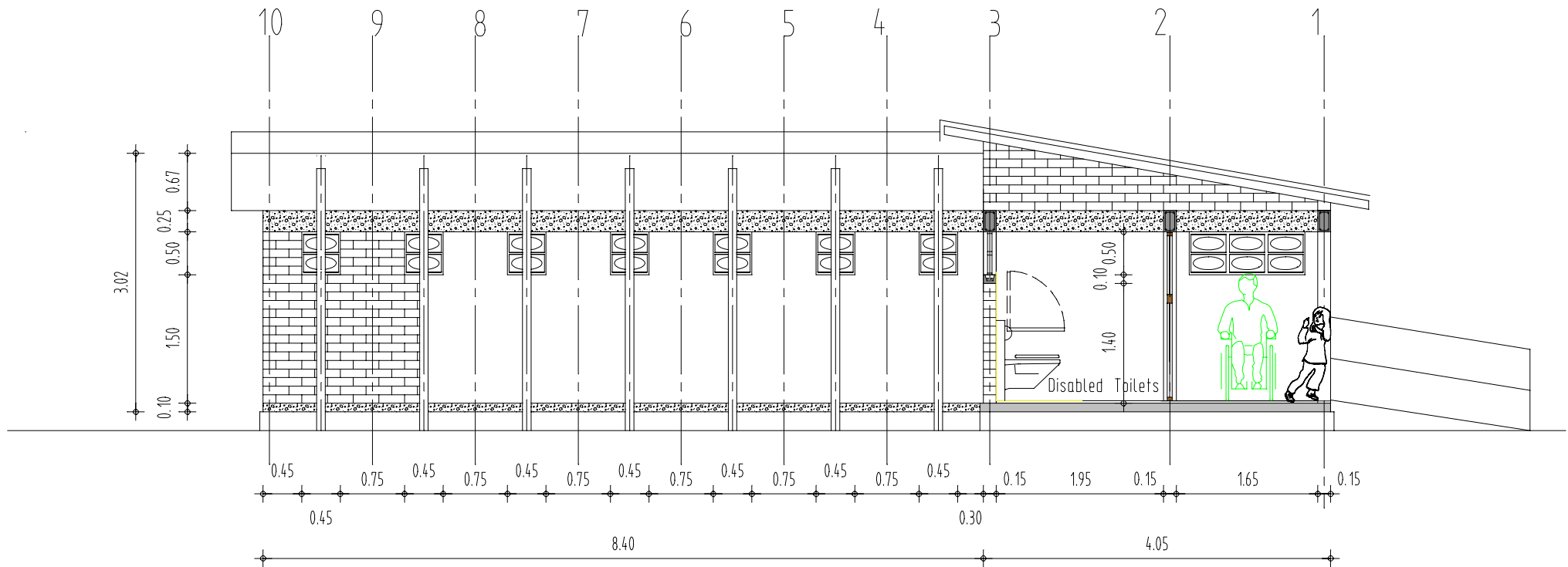

View axis D

29.08.2018

EMPLOYER	TITLE Tumaini CONSTRUCTION WORK Primary School	REPRESENTATION View axis D 12 Toilet Girls	DESIGNED BY F. Schramm Iringa P.O. BOX 1641
----------	---	--	--

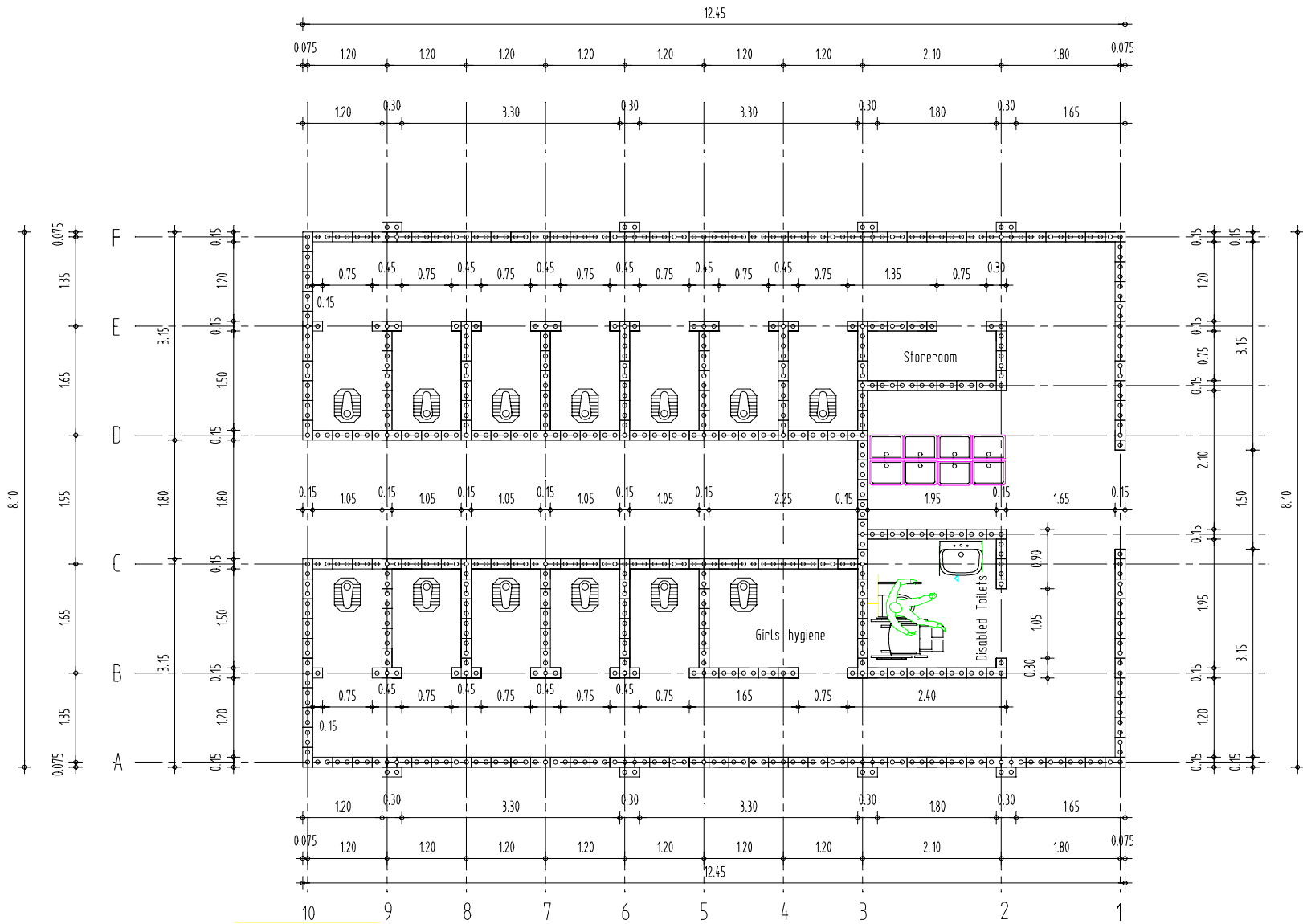

26.08.2018

EMPLOYER	TITLE	REPRESENTATION	DESIGNED BY
	Tumaini CONSTRUCTION WORK Primary School	Floor Plan 12 Toilet Girls	F. Schramm Iringa P.O. BOX 1641



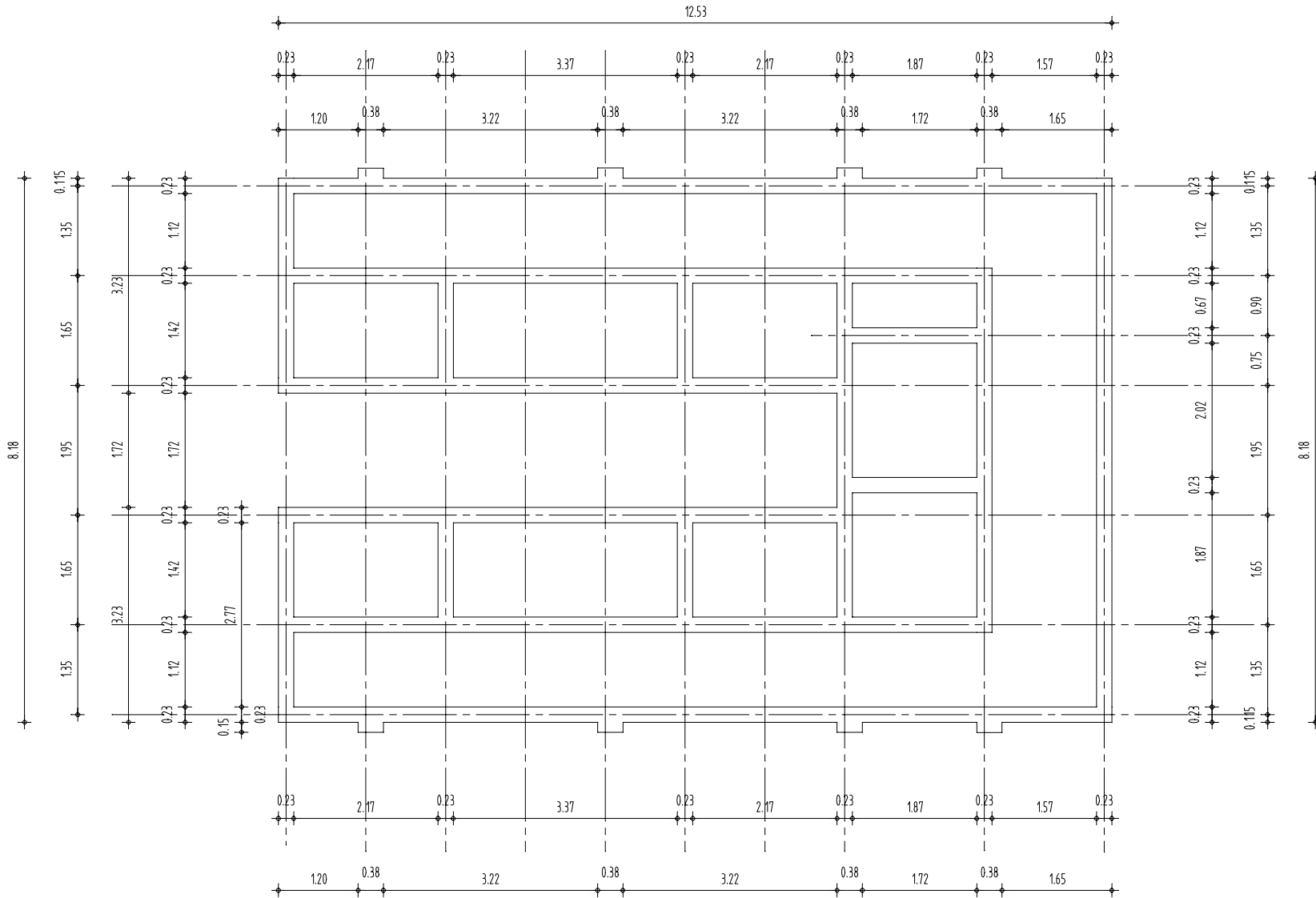

29.08.2018

EMPLOYER	TITLE	REPRESENTATION	DESIGNED BY
	Tumaini CONSTRUCTION WORK Primary School	Foundation 12 Toilet Girls	F . Schramm Iringa P.O. BOX 1641

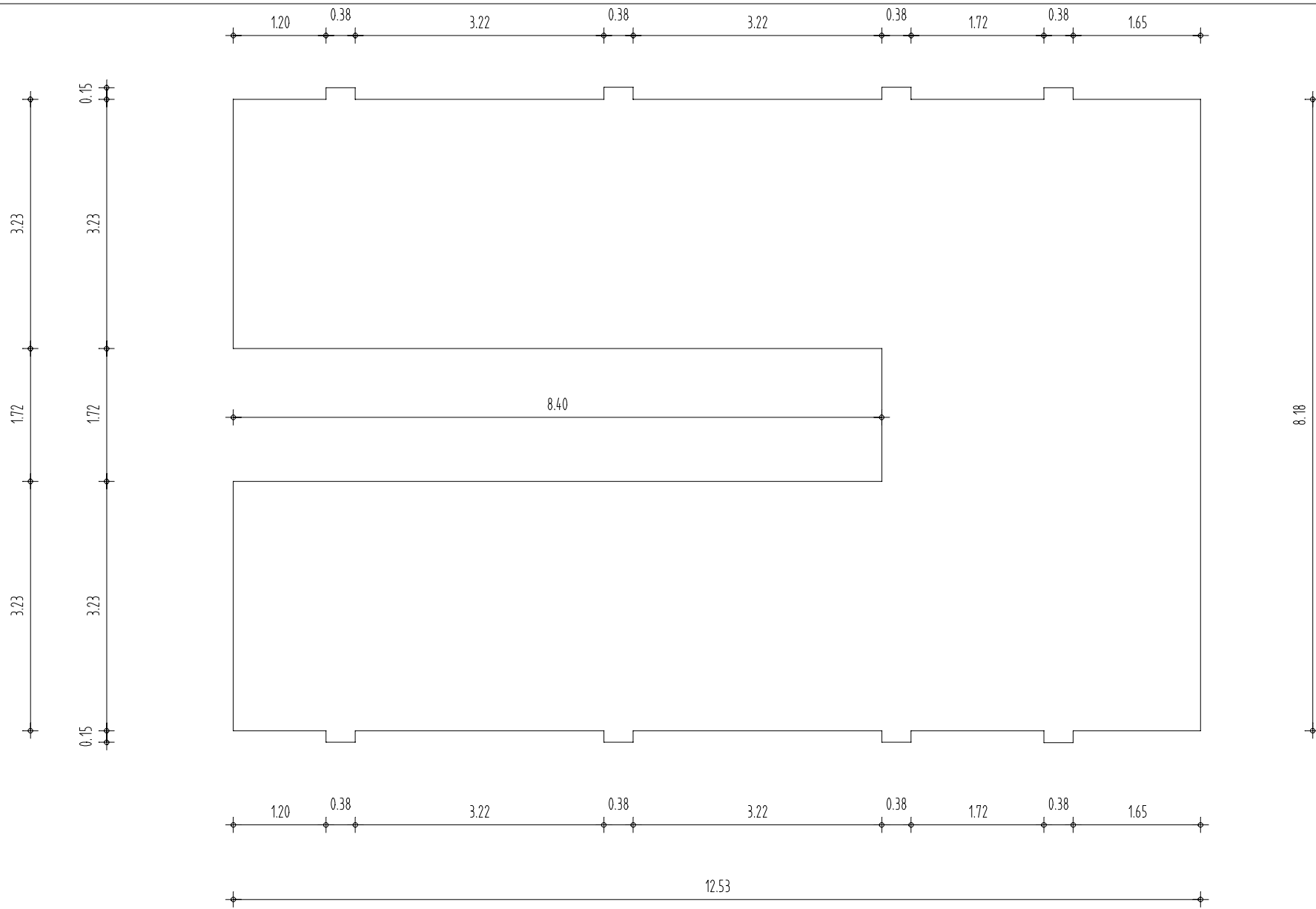

29.08.2018

EMPLOYER	TITILE Tumaini CONSTRUCTION WORK Primary School	REPRESENTATION Bottom plate 12 Toilet Girls	DESIGNED BY F . Schramm Iringa P.O. BOX 1641
----------	--	---	---